

COOLIUS

Y50

A/C Service-Unit for refrigerant R1234yf

Operating Manual



 Original Operating Manual

Introduction

Dear Customer,

Thank you for purchasing this product.

To ensure this condition and ensure safe operation, you must observe these operating instructions!

Read the entire operating instructions before using the machine for the first time. Observe all operating instructions and safety instructions!

All company names and product names are trademarks of their respective owners. All rights reserved.

If you have any questions, please contact the respective service partner of your country *See chapter 9 Contact and support p. 42.*

This machine meets the requirements of valid EU directives.

2014/68/EU (PED)

2006/42/EU

2014/30/EU

2014/35/EU

The declaration of conformity can be obtained from: www.coolius-ac.com

WOW! Würth Online World GmbH

Via della Punta 6/2

48018 Faenza (RA)

Italy



Contents

1 Important notes on the operating instructions	5
The purpose of this operating manual is:	5
Disclaimer	5
1.1 Important information about refrigerant	6
Safety Classification and information about refrigerant:	6
1.2 Symbols	7
1.3 Intended use	7
2 Important safety instructions	7
2.1 Glossary of terms	7
2.2 General safety rules	8
2.3 Guidelines for handling refrigerants	8
2.4 Safety devices	9
2.5 Not condensable gas discharge	9
2.6 Ventilation Safety System	9
2.7 The work environment	9
3 Use of the machine	10
3.1 Unpacking and checking the components	10
3.2 Machine description	10
3.2.1 Control panel	10
3.2.2 The machine	11
3.2.3 Transport lock	12
3.3 Machine handling	12
3.4 On/Off and stopping	12
4 Preparation for the use and settings	13
4.1 Machine start-up	13
Switch on the machine for the first time and activation	13
4.2 Using the printer	14
4.3 Program selection	15
Overview of the menu contents	15
4.4 Download Service data	16
4.5 Setting	18
4.5.1 Machine set-up	18
4.5.2 Time-Date	19
4.5.3 Company data	20
4.6 Automatic Internal flushing	20
4.7 Maintenance messages	21
4.8 Error messages	21
4.9 Vessel charge	22
5 Programs	24
5.1 New oil bottle change	24
5.2 Full service	25
5.3 A/C database	27
5.4 Owner DataBase	28
5.4.1 Creation of a vehicle	28
5.4.2 Selection of a vehicle	29
5.4.3 How to modify or delete a saved vehicle	29
5.5 Open program	30

5.5.1	Process setting	30
	Recovery	30
	Nitrogen Pressure Test	30
	Vacuum	32
	A/C system charge	32
5.5.2	A/C pressure test	33
5.6	A/C flushing (UNLOCK CODE required)	33
6	Maintenance	35
6.1	Operation history	35
6.2	Next service	35
6.3	Counter reset (UNLOCK CODE required)	36
6.4	Filter replacement	36
6.5	Vacuum pump oil replacement	37
6.6	Report	38
6.7	Scale reset	38
	6.7.1 Refrigerant weight scale	38
	6.7.2 Waste oil weight scale	39
7	Technical features	39
8	Disposal	41
8.1	Storage for long periods	41
8.2	Disposal of used fluids	41
8.3	Disposal of packaging material	41
8.4	Scrapping the old unit	41
9	Contact and support	42
9.1	Service Portal COOLIUS-AC.COM	42

1 Important notes on the operating instructions

COOLIUS Y50 (the machine) has been designed and built to ensure long lasting, high-level operating reliability with maximum safety for user.



This operating manual is part of the machine.
Read carefully before use.

- The user is responsible for the proper use of the machine in accordance with the instructions found in this operating manual.
- The manufacturer cannot be held responsible for damage to persons, animals and/or objects due to improper use different to that illustrated in this instruction manual.
- The manufacturer reserves the right to make technical and aesthetic alterations to the machine without prior notification.

The purpose of this operating manual is:

- To supply the user with all the information needed to use the unit starting from purchase on through to the disposal of this same machine.
- To ensure maximum support for the personnel assigned to the use and the maintenance of the machine.

For any special information or requests for technical assistance or spare parts, please contact the Service partner of your country.

Disclaimer



This manual was created with great care. However, if you notice any omissions or inaccuracies, please inform the service partner of your country in writing.

The manufacturer shall not be liable for technical or typographical errors and reserves the right at any time without prior notice to the product and the instruction manuals make.

The illustrations in this document may differ from the machine actually supplied with this manual.

1.1 Important information about refrigerant



NOTE: All the information here is current as of the date of printing of this manual.



WARNING! The machine is designed exclusively for R1234yf. The design meets all the guidelines of the European standard EN 378:2016

Safety Classification and information about refrigerant:

The refrigerant is classified in Table E.1 (Refrigerants designation) of Annex E (Normative) of the European standard EN 378-1:2008 + A1: 2010 (E) (EN 378-1:2011).

- PROPANE series: 1234yf (2,3,3,3-tetrafluoro-1-propene $\text{CF}_3\text{CF}=\text{CH}_2$)
- Safety group: A2L
- PED fluid group: 1



The refrigerant (R) 1234yf (HFO) is classified FLAMMABLE

The refrigerant can assume different names depending on the manufacturer!



For more information relating to the refrigerant refer to the SAFETY DATA SHEET according to Regulation (EC) No. 1907/2006 (MSDS).

The SAFETY DATA SHEET (MSDS) must be delivered to the operator (s) employee (s) using the machine!

HAZARDS IDENTIFICATION

Classification REGULATION (EC) No 1272/2008 Flammable gases 1

- H220 Extremely flammable gas.
- Gases under pressure Liquefied gas
- H280 Contains gas under pressure; may explode if heated.

DIRECTIVES 67/548/EEC or 1999/45/EC

- F+ Extremely flammable
- R12 Extremely flammable.

Tank label elements REGULATION (CE) N. 1272/2008

Hazard pictograms:

Signal word:

Danger



Hazard statements:

- H220 Extremely flammable gas.
- H280 Contains gas under pressure; may explode if heated.

Precautionary statements:

- P281 Use personal protective equipment as required.
P210 Keep away from heat/sparks/open flames/hot surfaces. No smoking.
P260 Do not breathe dust/ fume/ gas/ mist/vapours/ spray.
P308 + P313 IF exposed or concerned: Get medical advice/ attention.
P410 + P403 Protect from sunlight. Store in a well-ventilated place.

DIRECTIVES 67/548/EEC or 1999/45/EC Symbol(s):

- R-phrase(s): R12 Extremely flammable.
S-phrase(s): S 9 Keep container in a well-ventilated place.
S16 Keep away from sources of ignition – No smoking.



1.2 Symbols



This safety alert symbol indicates that this message involves personal safety. Works danger, warning and caution indicate degree of hazard. Death, personal injury and/or property damage may occur unless instructions are followed carefully.



Do not operate this machine if you have not read and understood the following safety items. Read this entire Operating Manual.

1.3 Intended use

The machine is designed solely for use in automobile air-conditioning system maintenance.



CAUTION! *Risk of injury due to improper use.*

This machine is intended for use by Qualified personnel only. Such users must have a knowledge of the basics of refrigeration, refrigeration system, refrigerants and the potential hazards that unit under high pressure can cause.

2 Important safety instructions

The user should follow the “general safety rules”, and use the machine according to the “intended use” and the instructions of this operating manual.

Therefore, the user is not exposed to any risk if the general safety rules reported below are followed with proper use and maintenance of the machine.

2.1 Glossary of terms

- **Machine:** The machine relative to this operating manual.
- **Refrigerant:** Fluid reported on the identification label.
- **A/C system:** Air-conditioning system in the vehicle.
- **External bottle:** New Refrigerant used to fill the internal vessel.
- **Internal vessel:** Refrigerant storage tank.
- **Process:** Execution of an individual function (Ex. Recovery).
- **Cycle:** Execution of more processes.
- **Recovery:** The recovery of refrigerant in any condition and its storage in a container outside the A/C system, without necessarily undergoing analysis or treatment of any kind.
- **Recycling:** A reduction of the contaminating substances in used refrigerants through oil separation, the recovery of incondensable and their single or multiple passages through elements that enable a reduction in humidity, acidity and gasses.
- **Disposal:** Recovery of refrigerant to store it for subsequent distribution or disposal.
- **Vacuum:** Phase in which air and moisture are evacuated from an A/C system solely by means of a vacuum pump.
- **Oil charge:** Introduction of oil inside an A/C system for the purpose of maintaining the amount of oil specified by the manufacturer.
- **UV dry charge:** Introduction of UV dye inside an A/C system in order to detect possible leaks by means of a UV lamp.
- **Refrigerant charge:** Phase during which refrigerant is introduced into an A/C system in the amount specified by the manufacturer.

- **Flushing:** at the purpose to clean the A/C system or components, liquid refrigerant is flushed through it, in order to do so a special device and adapters are needed.
- **Nitrogen pressure test:** Introduction of nitrogen inside an A/C system in order to detect possible leaks

2.2 General safety rules

- This machine is intended for use by QUALIFIED PERSONNEL only. Such users must have a knowledge of the basics of refrigeration, refrigeration system, refrigerants and the potential hazards that unit under high pressure can cause.
- It's essential to supervise the machine at all times.
- DO NOT modify the safety devices
- DO NOT use external tanks or other storage tanks that have not been type-approved or that lack safety valves.
- DO NOT use the machine near open flames and hot surfaces. At high temperatures, the refrigerant decomposes, releasing toxic and chemical substances that are hazardous for users and the environment.
- It's essential to use only the refrigerant indicated on the identification label. Mixtures with other types of refrigerant will seriously damage the cooling and refrigeration system, as well as the machine.
- Gloves and Goggles should be worn - contact with the refrigerant can cause blindness and other physical injury to the user.
- Avoid inhalation of vapours from the refrigerants and contact of the refrigerant with skin.
- Do not switch on the machine unless the machine is going to be used immediately. Cut off the electrical power supply prior to long intervals in which the machine will not be used.
- **Attention:** Ensure that all valves are closed before making connections between the machine and an A/C system or an external tank.
- **Attention:** Ensure that the process has been completed and that all valves are closed before disconnecting the machine.
- **Attention:** All of the flexible hoses may contain refrigerant under high pressure. Exercise extreme caution when disconnecting the service hoses.
- **Attention:** The machine and A/C system in vehicles containing refrigerant should not be tested with compressed air. Some mixtures of air and refrigerant have proven to be combustible at high pressure levels. These mixtures are potentially hazardous and there is a risk of fire and explosions that can cause damage to property and personal injury.
Additional medical and safety information can be obtained from the manufacturers of the oils and refrigerants.

2.3 Guidelines for handling refrigerants

Precautions for Refrigerant Storage

The refrigerant to be removed from a system must be handled carefully in order to prevent or minimise the possibilities of different refrigerants mixing.

The tank used for storing refrigerants must be assigned to specific refrigerants to avoid different refrigerants mixing

Recycling Capacity

The recycling machine's filter system should be replaced regularly in order to maintain the efficiency of the recycling machine

General Notions

Before re-introducing refrigerant into the system, the system itself must be evacuated and cleaned.

In order to be sure that the system is free of contaminating agents before introducing the refrigerant, all the procedures described in this instruction manual must be followed.

Clean and maintain the machine regularly, especially when highly contaminated refrigerant is used: it is extremely important that contamination from the previous operation is not transferred to subsequent operations.

2.4 Safety devices

The machine is equipped with the safety devices required from the European Directives:

- Electric safety switch
- Safety valve



CAUTION! *Danger of injury due to manipulation.
DO NOT MODIFY THE SAFETY DEVICES.*

2.5 Not condensable gas discharge

A not condensable gas discharge valve is installed to allow these gasses to be released.

The not condensable gas discharge valve could generate noises.



WARNING! *Risk of injury from escaping gases under high pressure.
Make sure that you never come in contact with the drain valve!*

2.6 Ventilation Safety System

The machine is designed for the refrigerant 1234yf classified as flammable.

For this reason, the machine is equipped with a ventilation security system which has the task, in case of leakage of the circuit, to avoid the formation of pockets of refrigerant.

It is forbidden to obstruct the inlet grid of the fan.

The user must monitor the efficiency of the ventilation security system and in case of anomaly of the same must switch off the machine.

In addition, the internal vessel is equipped with a normally closed electric valve which is activated only when the machine is ON.

2.7 The work environment

- The machine must be used in open environments or in places equipped with good ventilation (at least 4 changes of air per hour).
- The unit has been designed for use at a maximum altitude of 1000 m above sea level, within a temperature range of +10 and +49°C and with a maximum humidity of 50% at +40°C. Protect the machine from direct sun rays, rain, etc...
- Operate in sufficiently lit conditions.

3 Use of the machine

3.1 Unpacking and checking the components

Remove the machine packaging and ensure that the following parts are present:

- EC/PED documentation

3.2 Machine description

3.2.1 Control panel

1. Display
2. START button / LED
3. STOP button / LED
4. Information button (i)
5. Cancel button (X)
6. COOLIUS SELECT with ENTER button / LED
7. Right button / LED
8. Left button / LED
9. Printer
10. USB-Port
11. Mushroom safety switch

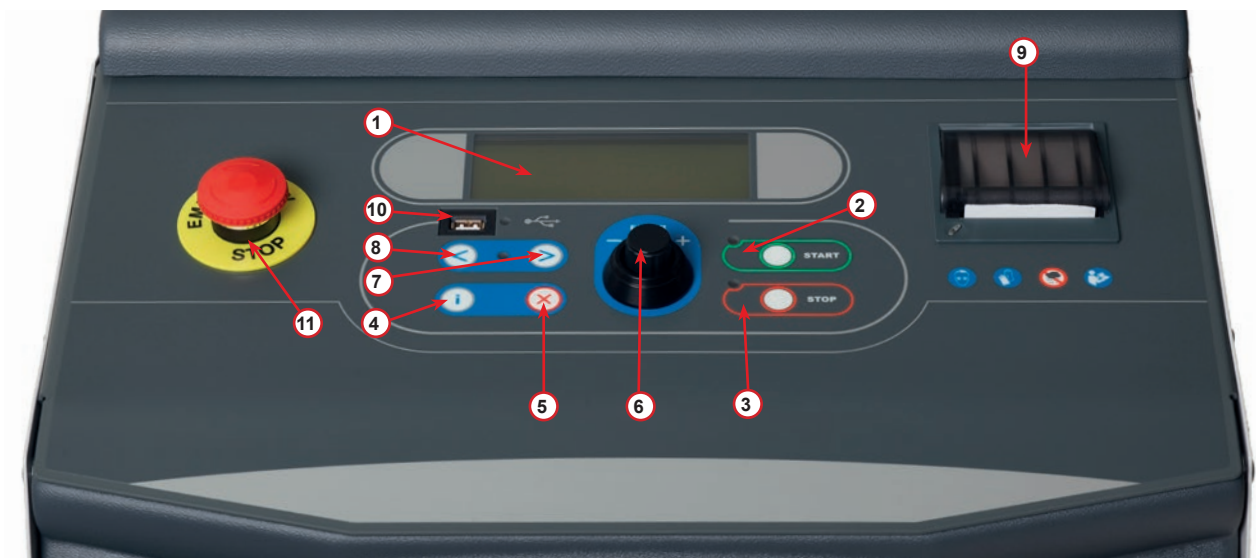

fig. 001 Operator panel

3.2.2 The machine

- 1 LP pressure indicator
- 2 HP pressure indicator
- 3 Internal vessel pressure gauge
- 4 Printer
- 5 Front cover
- 6 Rear wheel
- 7 Front wheel with brake
- 8 Drier filter
- 9 Main switch
- 10 Bottle for PAG oil 250 ml
- 11 Storage box for accessories
- 12 Bottle for POE oil 250 ml
- 13 Bottle for UV leak detection additive 100 ml
- 14 Drained oil sealed bottle 250 ml
- 15 LP quick coupling
- 16 HP quick coupling
- 17 LP hose
- 18 HP hose
- 19 By-pass
- 20 Front pocket
- 21 Scale lift knob
- 22 Inlet port for pressure test
- 23 Ventilation Security System inlet grid
- 24 Mushroom safety switch

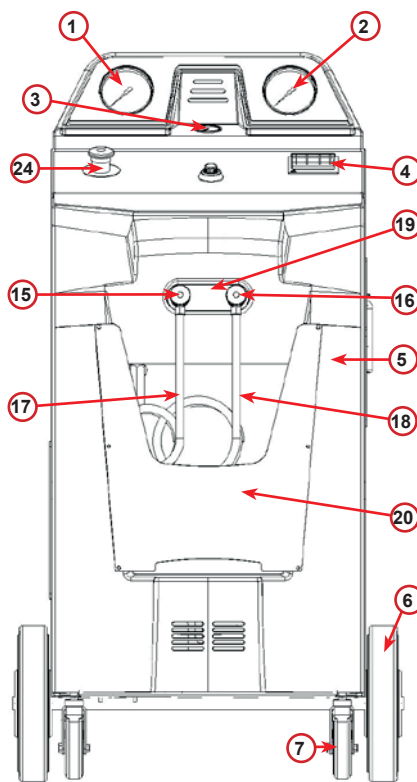

fig. 002 Front view

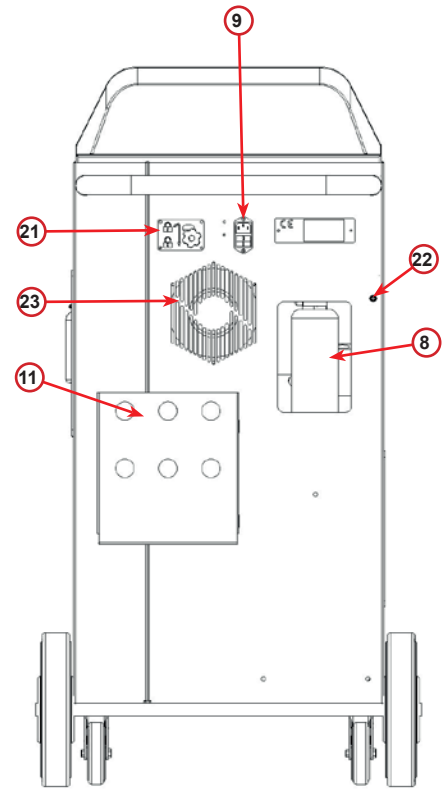

fig. 003 Rear view

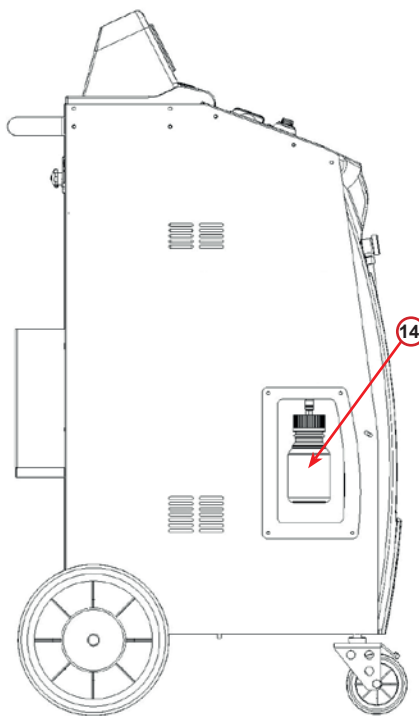

fig. 004 Left view

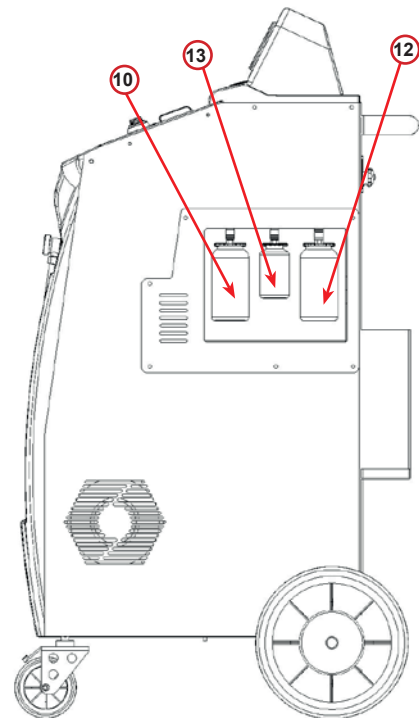
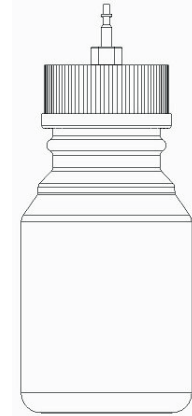

fig. 005 Right view



ATTENTION! *Damage to the machine.
The drained oil bottle is sealed!
Close the bottle by screwing the cap completely!
A wrong fitting may cause a malfunction of the unit!*



3.2.3 Transport lock

The transport lock secures the scale of the internal refrigerant vessel and protects it from damage during transport..

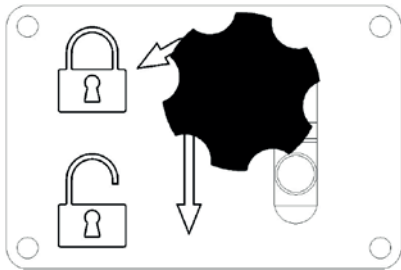

fig. 007 Scale locked

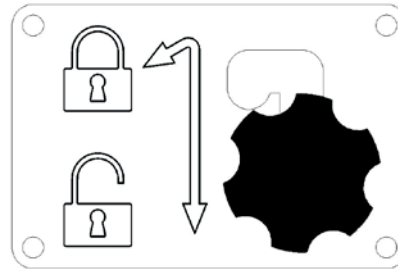

fig. 008 Scale unlocked, workposition

Attention! *Damage of the scale during transport
The transport lock must be locked before transporting the A/C service unit.*

Unlocking

Unscrew the star grip screw of the transport lock.

Raise the star grip screw, then move to the right and down to the unlocked position.

Retighten the star grip screw slightly.

locking

Unscrew the star grip screw.

Move the star grip screw upwards and then to the left to the locked position.

Retighten the star grip screw slightly.

3.3 Machine handling

In spite of the fact that the heaviest components have been assembled on the base in order to lower the centre of gravity, it has not been possible to eliminate the risk of overturning completely.

The machine is moved on the four wheels.

On rough ground, the machine must be moved by tilting it and balancing the weight on the two rear wheels.

3.4 On/Off and stopping

Start-up: Move the main switch to the ON position (I)

Stopping: Move the main switch to the OFF position (0)



ATTENTION! *Damage to the machine.
Do not switch off the machine by unplugging the plug!*

4 Preparation for the use and settings

4.1 Machine start-up

Press the Power Switch (I) to turn on the Machine.
The ventilation security system starts.

Switch on the machine for the first time and activation

Select the display language

Turn **COOLIUS SELECT** to select the language, then confirm by **ENTER**.

After selecting the language, you have two possibilities to work with the machine.

1. Demo Mode

You can now activate the machine or work in demo mode.

NOTE: All functions will be full working except for the **TIME - DATE** menu, that is not available.

- 1. Press **STOP** to use the machine in DEMO MODE. (The machine start-up and skip the activation procedure).
 - The display shows the number of days before the activation will be necessary to use the machine.
- 2. Press **START** to go to Stand-by mode.

2. Machine activation

- 1. Press **START** to activate the machine.

NOTE: After 10 days, starting from the first switch on, the display will show only this screen at the start-up.

- 2. To perform the activation, go to website www.coolius-ac.com or call the hotline +497940981888188 and request the UNLOCK CODE related to the Serial Number written on the display (in this case, the Serial Number is AA000000).
- 3. Press **START** to continue with activation or press **STOP** to skip the activation procedure and start-up the machine in DEMO MODE.

NOTE: **STOP** key is available only if there is at least one day left for DEMO MODE, otherwise the activation is compulsory and only the **START** key is available.

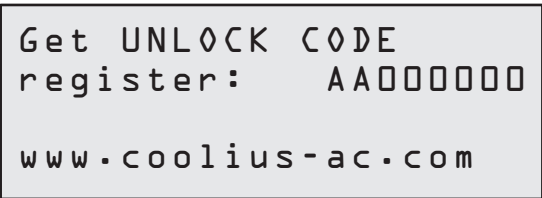
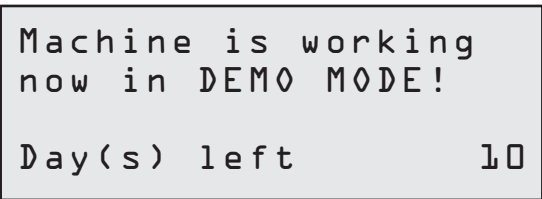
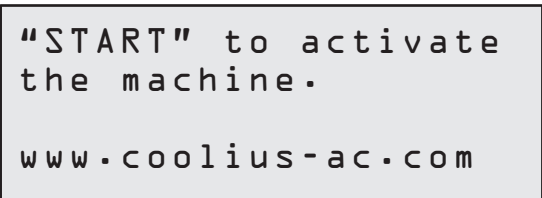
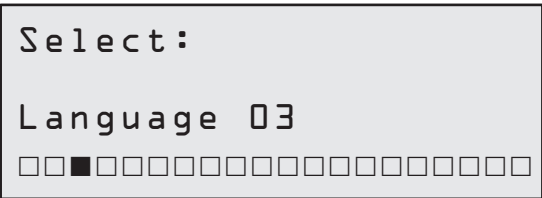

To continue with the activation it is required the knowledge of the UNLOCK CODE.

4. By the **COOLIUS SELECT** enter the UNLOCK CODE.
Once done, confirm by **START**.

- If the UNLOCK CODE is wrong, repeat the procedure just described.
- If the UNLOCK CODE is correct, press **START** to confirm. The machine is activated and shows the Stand-by mode.

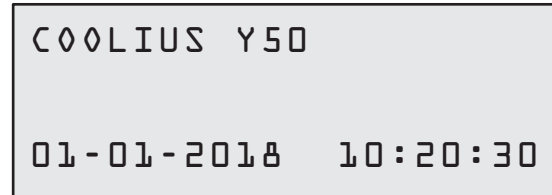
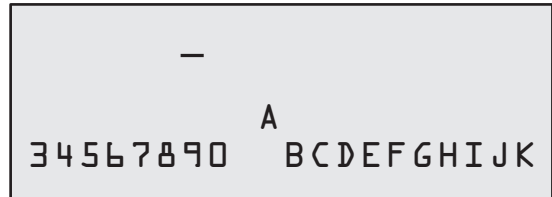

4.2 Using the printer

The machine has a built-in roll-up printer which can be used to print the vehicle data and the results of the services performed.

- Paper width: 58 mm
- Diameter: 40 mm
- Paper feed ①

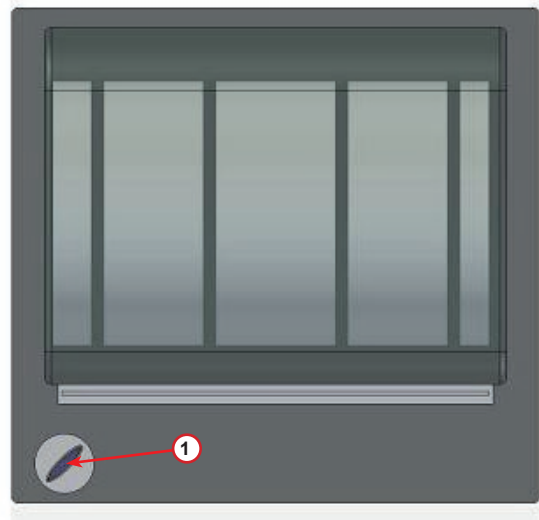

fig. 006 roll-up printer

Before a process:

Turn **COOLIUS SELECT** to select the character then confirm by **ENTER**.

Max 20 characters (plate, chassis, etc...).

At the end of a process:

Press **START** key to print.

Press **STOP** key to end.

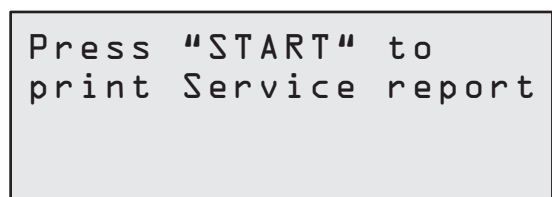
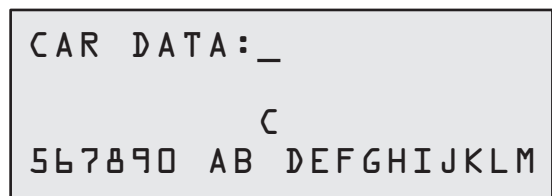

4.3 Program selection

Press **i** key to check the refrigerant available.

Press **i** key to come back in stand-by mode.

Press **ENTER** to select a menu item.

.

Turn **COOLIUS SELECT** to select the required program.

The symbol **■** shows the current position of the cursor.

The number of symbols **□** shows the number of available menu points of this level.

```
Available quantity:
Refrigerant   g.//////
01-01-2018   10:20:30
```

```
Full Service
```

```
□□■□□
```

Overview of the menu contents

1. OTHER SELECTIONS

- SERVICE
- A/C PRESSURE TEST
- A/C FLUSHING
- NEW OIL BOTTLE CHANGE
- MACHINE SET-UP
- TIME-DATE
- COMPANY DATA
- SCALE RESET
- MAINTENANCE

2. A/C DATABASE

3. FULL SERVICE

4. OPEN PROGRAM

5. VESSEL CHARGE

4.4 Download Service data

Starting from the first switch on of the new year, the display shows:

```
Download
SERVICE DATA!
```

Press **STOP** to by-pass or **START** to download.

NOTE: At the 3rd year, if the data has not been downloaded and deleted yet, only **START** is available. In this case, to unlock the **STOP** key is required to delete the data of at least one year.

If **START** is pressed, then the display shows:

Type the password: 014857

NOTE: This password can be also used in OTHER SELECTIONS > SERVICE

```
—
A
3 4 5 6 7 8 9 0  B C D E F G H I J K
```

Then the display shows:

Turn **COOLIUS SELECT** to select the year to be downloaded then press **START** to confirm, the display shows:

```
Year                2018
```

Insert an empty USB stick.

NOTE: The file-system of the USB stick must be FAT32, if not please format it.

```
Insert a USB stick!
```

The download starts when the stick is detected and the display shows:

```
Downloading!

Please wait!
Record                11/46
```

In the last line of the screen is indicated the progress of the downloading process.

NOTE: Please do not remove the USB stick during the process to avoid damages to the stick and to the machine.

When the download is completed, the display shows:

```
Download
Completed!
Remove USB stick
```

Remove the USB stick, then the display shows:

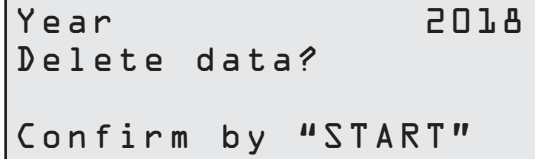

Year 2018
Delete data?
Confirm by "START"

Press **START** to delete the data or press **STOP** to exit and keep the data stored in the machine.

IMPORTANT-NOTE: Before deleting data, be sure that the downloaded file is kept in a safe place. The erasing process is not reversible!!

NOTE: At the 3rd year, if the data has not been downloaded and deleted yet, to unlock the "STOP" key is required to delete the data of at least one year.

If **START** is pressed, the display shows:

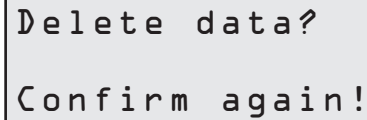

Delete data?
Confirm again!

Press **START** key to confirm or **STOP** to go back to previous screen.

If **START** is pressed, the display shows:



Please wait!

Wait a few seconds. The recorded data for the selected year is now deleted.

4.5 Setting

4.5.1 Machine set-up

The procedure allows to set the machine.

Turn **COOLIUS SELECT** to select MACHINE SET-UP. Press **ENTER** to confirm.

Recovery data:

- 1 The data are reported on the service printout (refrigerant quantity and oil).
- 0 The data are not printed.

```
Print recovery
data?
          1
```

Turn **COOLIUS SELECT** to select 1 or 0.

Press **ENTER** to confirm.

Refrigerant residual check:

The default value is applied in:

A/C DATABASE and FULL SERVICE

Turn **COOLIUS SELECT** to set. Press **ENTER** to confirm.

The next menu item is displayed.

```
Refrigerant residual
check
          min.  2
```

Leak test:

The default value is applied in:

A/C DATABASE and FULL SERVICE

Turn **COOLIUS SELECT** to set. Press **ENTER** to confirm.

The next menu item is displayed.

```
Leak test
          min.  2
```

Fresh oil:

The default value is applied in:

A/C DATABASE and FULL SERVICE

Turn **COOLIUS SELECT** to set. Press **ENTER** to confirm.

The next menu item is displayed.

```
Oil
          ml.  10
```

UV Dye:

The default value is applied in:

A/C DATABASE and FULL SERVICE

Turn **COOLIUS SELECT** to set the value. Press **ENTER** key to confirm.

NOTE: Set 0 to bypass the process

The next menu item is displayed.

```
UV Dye
          ml.  6
```

Hoses length

Turn **COOLIUS SELECT** to set the service hoses length, then confirm by **ENTER**.

The next menu item is displayed.

```
Set the HP hose
length (red hose)
cm.          300
```

Language:

Turn **COOLIUS SELECT** to select the language, then confirm by **ENTER**.

The next menu item is displayed.

```
Language 03
```

Unlock Code:

These eight digits are necessary to obtain the UNLOCK CODE for the counter reset. Request the new UNLOCK CODE on the website www.coolius-ac.com or by phone call to the hotline +497940981888188.

- Printer online (Activated).
- Printer off line or not installed.

Turn **COOLIUS SELECT** to select 1 or 0.
Press **ENTER** to confirm, then press **STOP** key to exit.

```
UNLOCK CODE:
BB111111
Serial Number:
AA000000
```

```
Optional
Printer      1
```

Nitrogen Pressure Test

- Automatic Nitrogen Pressure Test activated and automatically performed in the following programs:
A/C DATABASE and FULL SERVICE
- Automatic Nitrogen Pressure Test not activated.

Turn **COOLIUS SELECT** to select 1 or 0, then confirm by **ENTER**.

Automatic internal flushing.

- Automatic internal flushing activated (see Chap. 6.5)
- Automatic internal flushing not activated.

Turn **COOLIUS SELECT** to select 1 or 0, then confirm by **ENTER**.

```
Nitrogen Press-Test
AUTO
1
```

```
Automatic internal
flushing.
1
```

4.5.2 Time-Date

Turn **COOLIUS SELECT** to select TIME - DATE.
Press **ENTER** to confirm.

Turn **COOLIUS SELECT** to modify the blinking value.
Press **ENTER** to confirm. The next value blinks.
When the data is right press **START** key to confirm.

```
Time:          10:20:30
Date:          01/01/18
```

4.5.3 Company data

Turn **COOLIUS SELECT** to select **COMPANY DATA**.
Press **ENTER** to confirm.

5 lines are available:

- 1 _____ Company name (Workshop)
- 2 _____ Address (road, etc..)
- 3 _____ City
- 4 _____ Phone
- 5 _____ FAX

The above setting is an example only.

NOTE: *The five lines are reported on the service report.*

Procedure:

- Turn **COOLIUS SELECT** to select the character.
Press **ENTER** to confirm.
The character is reported on the first line (left).
- If required, press **X** key to delete.
- It is possible to move in the line by **LEFT / RIGHT**
- Turn **COOLIUS SELECT** to select the next character.
Press **ENTER** to confirm.
The character is reported on the first line.
- Press **START** key to confirm the setting.
The display shows the following line.
- Press **STOP** when the 5 lines are set.

```
1 _____  
C  
567890 AB DEFGHIJKLM
```

4.6 Automatic Internal flushing

The machine is equipped with two oil bottles (one for the PAG oil and one for POE oil). Due to low compatibility between the two kinds of oil, it is strongly suggested to avoid the mixing between the two.

In order to avoid contamination, the Automatic Internal flushing function performs a machine cleaning phase at the end of each process involving the oils.

This function can be deactivated if sure that only one type of oil is used with the machine (also in case of recovery!).



IMPORTANT-NOTE: *Excluding this function may cause anomalies in the A/C system and could create hazardous situations for the user (electric shocks on the A/C compressor unit)*

At the end of Vessel Charge, A/C Pressure Test, A/C Data-Base, Full Service, Open Program (only the ones including "Recovery" and/or "A/C System Charge"), the display shows:

Perform the instruction, then press **START** key to confirm.

At the end of the process:

Press **STOP** key to exit.

```
Join HP/LP couplers  
to the stands and  
Open the valves
```

```
Internal flushing  
end  
Machine ready!
```

4.7 Maintenance messages

At the start-up is possible to see the following messages:

Notice: "MAINTENANCE WILL EXPIRE SOON!" or
"MAINTENANCE EXPIRED"

Maintenance will expire soon!

Press **STOP** to continue with the start-up of the machine.

```
Maintenance will
expire soon!
Call for service
```

Maintenance expired!

1. At the message MAINTENANCE EXPIRED!
UNLOCK CODE REQUIRED press the **STOP** key, then
the display shows:

```
Maintenance expired!
UNLOCK CODE required
```



2. Write down the code shown at the end of the second line and use it to get the UNLOCK CODE on the website www.coolius-ac.com or by hotline phone call +497940981888188.
3. Press **STOP** to continue with the start-up of the machine.

```
Get UNLOCK CODE
register:      BB1111111
www.coolius-ac.com
```

NOTE: See chapter 6.3 Counter reset (UNLOCK CODE required) p. 36 to reset the maintenance counter.

4.8 Error messages

No	Error message	Description
A1	ERROR! Weight scale	Scale blocked or faulty (see 6.7 on p. 38)
C1	ERROR! Recovery	Recovery process anomaly or compressor faulty
	ERROR! Overpressure in recovery process!	High pressure switch activated. Wait 20/30 min. If the message appears again, please contact SERVICE CENTER.
	Vessel full! Please wait!	Maximum refrigerant quantity allowed! Reduce the refrigerant quantity in the internal vessel.
	Leakage! START to by-pass mb. ///	If after a few minutes the minimum value is not reached. Possible causes: defective A/C system, etc....
	Insufficient vacuum for oil/UV charge! „START“ to by-pass	The vacuum value is not enough to guarantee the process. Possible causes: defective A/C system, air in the bottles, etc... Press START to by-pass the process and go to charge process.
	Insufficient refrigerant. Charge the vessel.	The refrigerant quantity is below the minimum quantity required. Perform "Vessel charge".
F1	Error! A/C System Charge	The pressure is too low to complete the A/C System Charge (in case of A/C System Charge performed by "LP PORT" only).

No	Error message	Description
	Last internal flushing process not completed	<p>Internal flushing of last process was not correctly completed. Press START key to perform it again.</p> <p> ATTENTION! <i>The following procedure is STRONGLY DISCOURAGED! Please read See chapter 4.6 Automatic Internal flushing p. 20 and PROCEED AT YOUR OWN RISK!</i></p> <p> NOTE: <i>Is possible to skip the cleaning process by keeping pressed down the STOP key for 5 seconds.</i></p>

4.9 Vessel charge

The equipment may not contain enough refrigerant to run. The available quantity could be negative (Es: -500 g.) It will be necessary to add new refrigerant into the internal vessel before the use (at least 3 or 4 Kg).

1. Turn **COOLIUS SELECT** to select VESSEL CHARGE. Press **ENTER** to confirm.



NOTE: *The message is shown before processes.*

WARNING!
Verify Oil/UV
quantity in the
bottles.

2. Connect the LP (BLUE) or the HP (RED) hose to a new tank of refrigerant. If available, open the liquid tank valve (RED).
Otherwise turn the tank up-side-down.

Connect LP or HP
hose to ext. tank.
Open the valve
liquid side.

3. Turn **COOLIUS SELECT** to set the value.
 - Minimum: 800 g.
 - Maximum: the value shown by the display.
4. Press **ENTER** to confirm..

Set the quantity.

g. // // // //

5. Press **START** key to confirm

Confirm by "START"



MESSAGE: *If the equipment senses a pressure lower than the minimum value for the process.*

```
Check:
Ext. tank empty or
tank valve closed.
```

The process starts.

```
Vessel charge in
process.
Pressure      mb.
Refrigerant   g./////
```



MESSAGE: *If the equipment senses a pressure lower than the minimum value for the process.*

- Replace the external tank, then press **START** key to confirm.
- Press **STOP** key to complete the process.

```
Check:
Ext. tank empty or
tank valve closed.
```

The process is completed.

6. Close the tank valve and disconnect the red hose from the tank.

Press **START** key to confirm.

```
Vessel charge end.
Close the external
tank valve.
```

```
Refrigerant recovery
from the
service hoses
```

7. Press **STOP** key to end.

The machine now performs a self-cleaning process
 See [chapter 4.6 Automatic Internal flushing p. 20](#)
 if "Automatic internal flushing" is activated under
 MACHINE SET-UP See [chapter Automatic internal
 flushing. p. 19](#).

Otherwise it goes to stand-by mode.

```
Vessel charge end.
g./////
```

5 Programs

5.1 New oil bottle change



NOTE: A/C System can be damaged.

If it is required to change the kind of compressor oil, the A/C machine will require flushing to prevent cross contamination of oils. This procedure cleans the hoses and pipes prior to new oil injection.

1. Turn **COOLIUS SELECT** to select OTHER SELECTIONS.

Press **ENTER** to confirm.

2. Turn **COOLIUS SELECT** to select NEW OIL BOTTLE CHANGE.

Press **ENTER** to confirm

New oil bottl.change

□□□■□□□□□

3. Turn **COOLIUS SELECT** to select the bottle that has to be replaced (PAG oil or POE oil).

Press **ENTER** to confirm.

Select oil type:

PAG oil

4. Replace the oil bottle with the new oil bottle.

Press **ENTER** to confirm.

Replace oil bottle
with the new oil
bottle for specific
application.

5. Perform the instruction.

Press **START** key to confirm.

Join HP/LP couplers
to the stand and
open the valves!
Confirm by "START"

6. The machine starts.

Internal flushing
Wait!

If the couplers are not joint to the stand or the coupler valves are not closed, message:

7. Press **START** key to confirm.
The machine starts. The process cleans the complete unit included the service hoses.

Join HP/LP couplers
to the stand and
open the valves!
Confirm by "START"

At the end:

8. Press **STOP** key to exit.
The machine is ready.

Internal flushing
end.

5.2 Full service

1. Press **ENTER** to go to selection menu (if in Stand-by mode).
2. Turn **COOLIUS SELECT** to select "FULL SERVICE"
3. Press **ENTER** to confirm.

Full service

□□■□□

4. Turn **COOLIUS SELECT** to set the amount of refrigerant to be charged into the A/C system.

- Minimum: 50 g.

5. Press **ENTER** to confirm.

Refrigerant g. 500

6. Turn **COOLIUS SELECT** to set
AUTOMATIC / MANUAL / NO
Press **ENTER** to confirm.

Oil/UV charge

Automatic

If AUTOMATIC or MANUAL is selected, then the display shows:

7. Turn **COOLIUS SELECT** to set PAG OIL or POE OIL

Press **ENTER** to confirm.

Select Oil Type

PAG Oil

If AUTOMATIC is selected, then the display shows:

8. Turn **COOLIUS SELECT** to set oil quantity, confirm by **ENTER**, then set UV quantity and press **ENTER** to confirm.

PAG Oil	ml.	—
UV dye	ml.	—

9. Turn **COOLIUS SELECT** to set (usually HP)
HP PORT / LP PORT / HP/LP PORTS

Press **ENTER** to confirm.

Equipment with printer: [See chapter 4.2 Using the printer p. 14](#)

Charge A/C system by

HP PORT

10. Press **START** key to confirm.
The equipment performs all the processes.
 - Recovery
 - Residual refrigerant check
 - Used oil drain process
 - Nitrogen Pressure test (if Nitrogen Press. Test AUTO is set to 1 in MACHINE SET-UP).
 - Vacuum, Leak test
 - New oil charge
 - UV Dye charge
 - Refrigerant charge

Confirm by "START"

11. At the end of the processes, start the engine and A/C system, then check the pressures.

Verify the A/C
system pressures.

12. At the end of the verification, press **STOP** key to end.
Perform the instruction.

Disconnect the HP/LP
service hoses from
the A/C system.

13. Press **START** key to confirm.

Refrigerant recovery
from the
service hoses

At the end, all the process values are reported on the display.

Recovery
Refrigerant g. ////
Oil ml. //

Vacuum
mb. ///

14. Press **STOP** key to end.
Equipment with printer: [See chapter 4.2 Using the printer p. 14](#)
15. Press **START** key to print or **STOP** key to skip.

A/C system charge
Quantity g. ////

The machine performs a self-cleaning process
[See chapter 4.6 Automatic Internal flushing p. 20](#) if “Automatic internal flushing” is activated under
MACHINE SET-UP [See chapter Automatic internal flushing. p. 19](#).
Otherwise it goes to stand-by mode.

5.3 A/C database

The memory contains the data of the main cars on the market.

1. Press **ENTER** to go to selection menu (if in Stand-by mode).
2. Turn **COOLIUS SELECT** to select "A/C DATABASE"
Press **ENTER** to confirm.

A/C DataBase

□ ■ □ □ □

3. Turn **COOLIUS SELECT** to select the brand.
Press **ENTER** to confirm.

Hyundai

4. Turn **COOLIUS SELECT** to select the model.
Press **ENTER** to confirm.

Hyundai
i30

5. Turn **COOLIUS SELECT** to select the version of the vehicle.
Press **ENTER** to confirm.

Hyundai
i30

2012-

6. Refrigerant quantity and oil viscosity are shown.

Hyundai
i30

PAG FD46XG ml. 150
g. 500

7. For more information, press **i** key.

Please refer to
the car manufacturer
technical
specifications!

Press **i** key to go back.

8. Press **START** key to confirm.
The program is performed like [See chapter 5.2 Full service p. 25.](#)

Hyundai
i30

PAG FD46XG ml. 150
g. 500

The display shows:

9. Turn **COOLIUS SELECT** to set PAG OIL or POE OIL.

Select Oil Type

PAG Oil

Press **ENTER** to confirm.

- Turn **COOLIUS SELECT** to set (usually HP)
HP PORT / LP PORT / HP/LP PORTS

Press **ENTER** to confirm.

```
Charge A/C system by
HP PORT
```

At the end The machine performs a self-cleaning process
See chapter 4.6 Automatic Internal flushing p. 20 .if “Automatic internal flushing” is activated under
MACHINE SET-UP *See chapter Automatic internal flushing. p. 19*.
Otherwise it goes to stand-by mode.

5.4 Owner DataBase

In the OWNER DATABASE, you have the ability to create your own, frequently used vehicle data.

5.4.1 Creation of a vehicle

- Enter in A/C DATABASE.

Turn **COOLIUS SELECT** counter clockwise, the display shows:

Confirm by **ENTER**.

NOTE: The display could show PLEASE WAIT! for a very short time.

```
Owner DataBase
```

- The display shows:

Confirm by **ENTER** to create a new vehicle or **STOP** to exit.

```
New Model?
```

- Type the brand of the vehicle.

NOTE: The field cannot be empty and a space is not allowed as a first character.

- When the brand is filled, press **START** to confirm.

```
Brand :
█ A
3 4 5 6 7 8 9 0 B C D E F G H I J K
```

- Type the model of the vehicle.

NOTE: The field cannot be empty and a space is not allowed as a first character.

- When the model is filled, press **START** to confirm.

```
Model :
█ A
3 4 5 6 7 8 9 0 B C D E F G H I J K
```

- Set the quantity of refrigerant by **COOLIUS SELECT** (from 50 to 5.000). Press **START** to save.

The record is saved in alphabetical order.

```
Quantity :
g . 500
```

5.4.2 Selection of a vehicle

1. Enter in A/C DATABASE.

Turn COOLIOUS SELECT counter clockwise, the display shows:

```
UserBrand
UserModel
INFO          g . 500
```

2. Turn **COOLIOUS SELECT** to select the desired vehicle, then press **ENTER** to use it, or **STOP** to exit.

```
Automatic
```

3. Turn **COOLIOUS SELECT** to choose between:

- **AUTOMATIC:** The machine performs a complete process using the default values for oil and UV (set in MACHINE SET-UP).
- **MANUAL:** The machine goes to the complete process set-up
[See chapter 5.5 Open program p. 30](#)
RECOVERY / NITROGEN PRESS. TEST
/ VACUUM / A/C SYSTEM CHARGE.

NOTE: Set the Nitrogen test time to 0 minutes to bypass the pressure test.

4. Press **ENTER** to confirm or **STOP** to go back to the Owner DataBase list of vehicles.

5.4.3 How to modify or delete a saved vehicle

1. Enter in A/C DATABASE.

Turn COOLIOUS SELECT counter clockwise, the display shows:

```
UserBrand
UserModel
INFO          g . 500
```

2. Press **i** (INFO) key, then the display shows:

```
Modify
```

3. Turn **COOLIOUS SELECT** to select between **MODIFY** and **DELETE**, then press **ENTER** to confirm or **STOP** to go back to the Owner DataBase list of vehicles.

- **MODIFY:** Overwrite the existing **BRAND**, **MODEL** and **Quantity** fields for the selected vehicle as shown in CREATION OF A VEHICLE.
[See chapter 5.4.1 Creation of a vehicle p. 28](#)

- **DELETE:** Press **START** to confirm when the display shows:

```
Delete

Confirm by "START"
```

Wait a few seconds.

NOTE: The waiting time increases as the number of vehicles in the Owner DataBase becomes larger.

The vehicle is now deleted and the machine goes to the Owner DataBase list of vehicles.

5.5 Open program

1. Press **ENTER** to go to selection menu (if in Stand-by mode).

Open program

□□□■□

2. Press **ENTER** to confirm.

3. Turn **COOLIUS SELECT** to select the program or more programs.

Recovery

The following selections are available:

- "RECOVERY"
- "NITROGEN PRESSURE TEST"
- "VACUUM"
- "A/C SYSTEM CHARGE"
- "RECOVERY / VACUUM"
- "VACUUM / A/C SYSTEM CHARGE"
- "RECOVERY / NITROGEN PRESSURE TEST / VACUUM / A/C SYSTEM CHARGE"

4. Press **ENTER** to confirm.

5.5.1 Process setting

Recovery

1. Turn **COOLIUS SELECT** to set the value.

- Minimum: 1 min.
- Maximum: 60 min.

Residual refrigerant
check.

min. 2

2. Press **ENTER** to confirm.

At the end The machine performs a self-cleaning process

[See chapter 4.6 Automatic Internal flushing p. 20](#) if "Automatic internal flushing" is activated under MACHINE SET-UP

[See chapter Automatic internal flushing. p. 19.](#)

Otherwise it goes to stand-by mode.

Nitrogen Pressure Test



ATTENTION! *Damage to the machine.
Maximum allowed pressure 12 bar!
Please refer to OEM instructions for Nitrogen Pressure Test!*

1. Turn **COOLIUS SELECT** to set the Nitrogen test time.

- Minimum: 1 min.
- Maximum: 60 min.

Nitrogen Press.Test

min. 3

2. Press **ENTER** key to confirm.

3. Enter CAR DATA, then the display shows:

```
Please connect
nitrogen bottle
to press. test
inlet port
```

4. Press **START** to confirm.

The nitrogen valve fills the A/C System.

When the pressure is stable, the machine checks possible leaks for the time set.

```
Nitrogen Press.Test
in process
```

```
Pressure      mb. 6500
```

5. At the end, the exhaust nitrogen valve empties the A/C System.

```
Nitrogen Press.Test
in process
Time          sec. 120
Pressure      mb. 6500
```

```
Nitrogen Press.Test
in process
```

```
Pressure      mb. 6500
```

Process end.

```
Nitrogen Press.Test
OK!
```



MESSAGE: *If charging pressure is too low (below the minimum allowed threshold).*

Press **STOP** to exit.

```
Not enough
pressure to test the
A/C system!
```



MESSAGE: *If during the test a leak is detected:*

Press **STOP** to exit.

```
Leakage in the
A/C system
under test.
```

Vacuum

1. Turn **COOLIUS SELECT** to set the vacuum time.

- Minimum: 20 min.
- Maximum: 900 min.

```
Vacuum time      min. 20
Leak test        min.  _
```

2. Press **ENTER** to confirm.

3. Turn **COOLIUS SELECT** to set the leak test time.

- Minimum: 2 min.
- Maximum: 60 min.

4. Press **ENTER** to confirm.

A/C system charge

A) In case of vacuum selected:

1. Turn **COOLIUS SELECT** to select the oil type (PAG oil or POE oil).
Press **ENTER** to confirm.

```
Select oil type:
PAG oil
```

1. Turn **COOLIUS SELECT** to set the Fresh oil value.

NOTE: The value indicates only the new oil added to the drained oil.

- Minimum: 0 g.
- Maximum: 150 g.

2. Press **ENTER** to confirm.

3. Turn **COOLIUS SELECT** to set the refrigerant amount.

- Minimum: 50 g.

4. Press **ENTER** to confirm.

```
PAG Oil          ml. 10
UV Dye           ml.  _
Refrigerant      g.  _
```

B) In case of vacuum not selected:

```
Refrigerant
g.  _
```

C) In case of A/C system charge:

5. Turn **COOLIUS SELECT** to set (usually HP).
HP P0RT / LP P0RT / HP/LP P0RT

6. Press **ENTER** to confirm.

7. Input CAR DATA, then press **START** key to confirm.
The equipment performs all the selected processes.

```
Charge A/C system by
HP P0RT
```

At the end The machine performs a self-cleaning process [See chapter 4.6 Automatic Internal flushing p. 20](#) if "Automatic internal flushing" is activated under MACHINE SET-UP [See chapter Automatic internal flushing. p. 19](#).

Otherwise it goes to stand-by mode.

5.5.2 A/C pressure test

This procedure allows to check the A/C system (pressures) without recovering refrigerant from the system.

1. Press **ENTER** to confirm.

A/C Pressure Test

□ ■ □ □ □ □ □ □ □ □

2. Perform the pressure test.
At the end confirm by **STOP**.

Verify the A/C
system pressures

NOTE: If a temperature probe is connected to the machine,
then the value is shown in the 4th row of the screen.

3. Perform the instruction.
Press **START** to confirm

Disconnect the HP
service hose (red)
from the A/C system

4. Wait the end.

Refrigerant recovery
from the
service hoses.

At the end The machine performs a self-cleaning process
See chapter 4.6 Automatic Internal flushing p. 20
if "Automatic internal flushing" is activated under
MACHINE SET-UP *See chapter Automatic internal flushing. p. 19.*
Otherwise it goes to stand-by mode.

5.6 A/C flushing (UNLOCK CODE required)

At the purpose to activate the A/C flushing process, please request the UNLOCK CODE on the website
www.coolius-ac.com or by phone call to the hotline +497940981888188.

1. Press **START** to confirm.

Get UNLOCK CODE
register: CC222222

www.coolius-ac.com

2. By the **COOLIUS SELECT** enter the UNLOCK CODE

A*****

3. Once done, confirm by **START**.

A
34567890 BCDEFGHIJK



In order to clean the vehicle A/C system, the equipment performs a washing process in “single or Multi pass” (multiple flushes).

For more details, refer to the A/C system manufacturers.

1. Press **ENTER** to confirm.
2. Turn **COOLIUS SELECT** to select **OTHER SELECTIONS** confirm by **ENTER** then **A/C FLUSHING**.
3. Press **ENTER** to select.

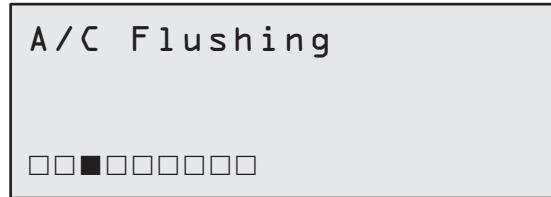

4. Turn **COOLIUS SELECT** to set from 01 to 04 steps (flushes).

Enter **CAR DATA** and press **START** to confirm.

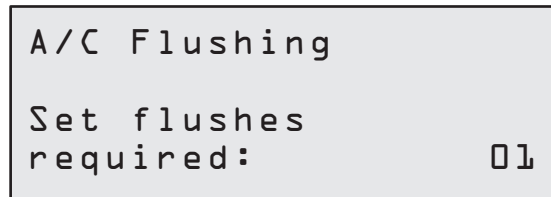

5. Press **START** key to confirm.

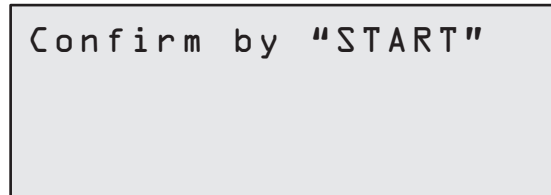

The “Single or Multi pass” process is carried out.

NOTE: *Appropriate adaptors for the compressor/expansion valve are required.*

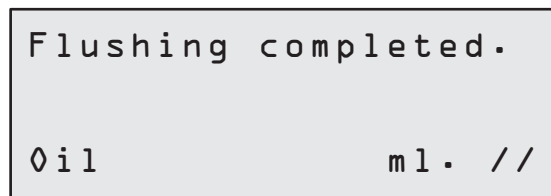
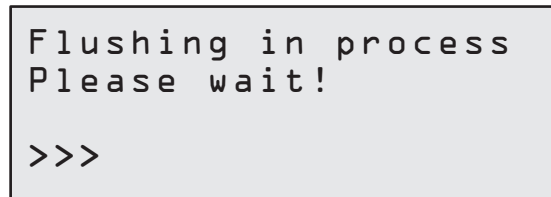

At the end, the machine performs a self-cleaning process [See chapter 4.6 Automatic Internal flushing p. 20](#) if “Automatic internal flushing” is activated under **MACHINE SET-UP** [See chapter Automatic internal flushing. p. 19](#).

Otherwise it goes to stand-by mode.

6 Maintenance



ATTENTION! *Damage to the machine!*
Maintenance can be made exclusively by *SERVICE CENTER* authorized by the manufacturer.

1. Press **ENTER** to go to selection menu (if in Stand-by mode).
2. Turn **COOLIUS SELECT** to select "OTHER SELECTIONS" and confirm by **ENTER**. Then select "Maintenance" and confirm by **ENTER**.

```
Select:
Historical counters
```

Available selections:

- HISTORICAL COUNTERS
 - NEXT SERVICE
 - COUNTER RESET
(UNLOCK CODE required)
 - REPORT
3. Press **ENTER** to confirm.

6.1 Operation history

By this menu is possible to check the operation history of the machine. The data are not erasable!

1. Turn **COOLIUS SELECT** to select the following counters:
 - REFRIGERANT RECOVERED FROM A/C SYSTEM
 - REFRIGERANT RECOVERED FROM EXTERNAL TANK
 - REFRIGERANT CHARGED TO A/C SYSTEM
 - VACUUM WORKING TIME

```
Select counter.
HF0 recovered
Total
Kg.           ///.//
```

6.2 Next service

By this menu is possible to check the next service required:

```
Maintenance within
                                min.
pump working time.
```

6.3 Counter reset (UNLOCK CODE required)



NOTE: Change the filter and/or the vacuum pump oil before reset!

NOTE: Only genuine spare parts or their equivalent. The use of replacement parts which are not of equivalent quality may damage the machine!

Go to website www.coolius-ac.com or call the hotline +497940981888188 to get the UNLOCK CODE for maintenance counter reset..

1. Press **ENTER** to type the unlock code.
2. By the **COOLIUS SELECT** enter the UNLOCK CODE.
Once done, confirm by **START**.
 - If the UNLOCK CODE is wrong, repeat the procedure.
 - If the UNLOCK CODE is right, the display shows:
3. Press **X** key to confirm.

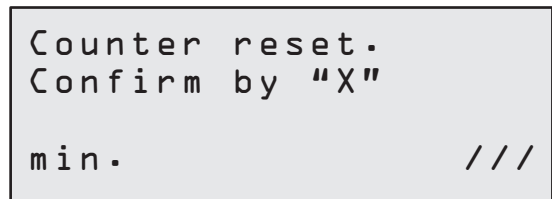
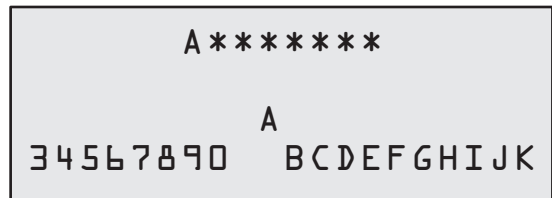

4. Press **X** key to confirm.

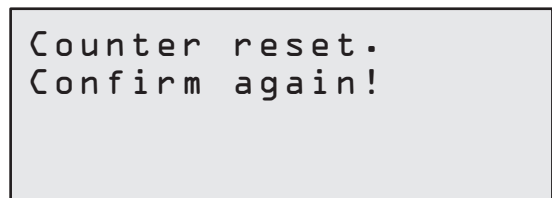

6.4 Filter replacement



ATTENTION! Risk of injury from leaking refrigerant.

Contact with the refrigerant can cause blindness and other physical injury to the user!

Always use goggles and gloves!



1. Before dismantling the filter, start a recovery process to reduce the internal pressure!



ATTENTION! Risk of injury from electric shock.

Before working on the machine, always disconnect the plug from the power supply.

The maintenance of the filter can be performed by the inspection hole placed on the back side of the equipment.

2. By 38 mm **②** wrench unscrew the filter **①**.



NOTE! Disposal in according to local directives!

3. Lubricate and place correctly the new O-rings.
4. Assembly the new filter.

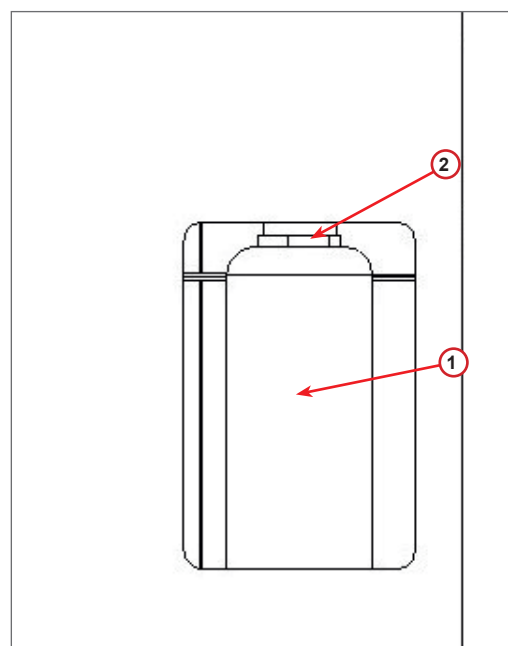

fig. 007 Filter replacement

6.5 Vacuum pump oil replacement



ATTENTION! Risk of injury from leaking refrigerant.
Contact with the refrigerant can cause blindness and other physical injury to the user!
Always use goggles and gloves!



ATTENTION! Risk of injury from electric shock.
Before working on the machine, always disconnect the plug from the power supply.



NOTE! The oil extracted must be delivered to used oil collection centre!

1. Dismount the front cover.
2. Unscrew the oil discharge screw and wait for the oil to drain. Refit discharge screw.
3. Unscrew the muffler.
4. Fill with new oil. The correct oil level of the pump is around half sight glass.
5. Refit the muffler.

NOTE: The picture could show a different type of vacuum pump.

- (1) Muffler
 - (2) Sight glass to indicate the oil level
 - (3) Discharge screw
6. Close the front cover.
The machine cannot be used with the front cover opened.

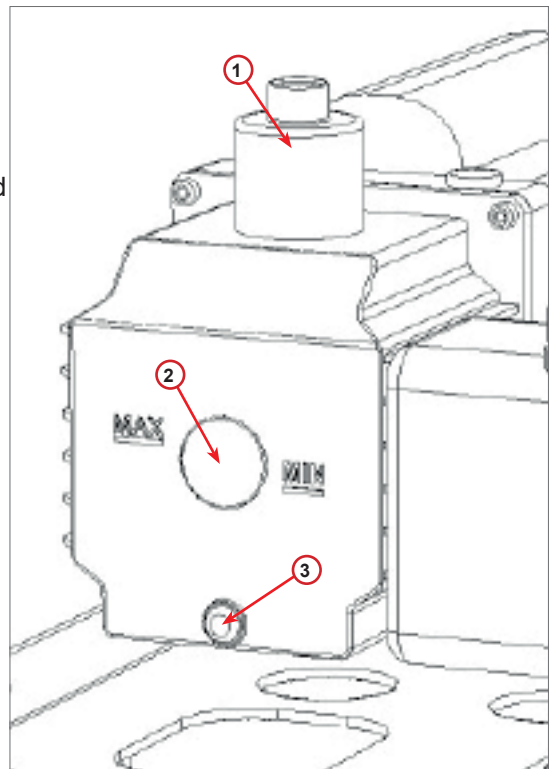

fig. 008 Vacuum pump

6.6 Report

The machine records the refrigerant usage monthly for the previous twelve months. Beyond this period, it will overwrite the data for the month in question.

1. Turn **COOLIUS SELECT** to select the following counters:
 - "REFRIGERANT RECOVERED FROM A/C SYSTEM"
 - "REFRIGERANT RECOVERED FROM EXTERNAL TANK"
 - "REFRIGERANT FILLED TO A/C SYSTEM"

```
01/2018
HF0 recovered
Kg.                10.0
```

The display shows in sequence all the months and the total per year.

2. Press **START** to print the report.

```
2018
Total
HF0 recovered
Kg.                210
```

6.7 Scale reset

At the purpose to compensate the scale deviation, perform the following instructions:

1. Turn **COOLIUS SELECT** to select OTHER SELECTIONS, confirm by **ENTER**,
2. Turn **COOLIUS SELECT** to select SCALE RESET
3. Press **ENTER** to confirm.

```
Scale reset
□□□□□□■□
```

4. Turn **COOLIUS SELECT** to select the scale:
 - "REFRIGERANT WEIGHT SCALE"
 - "WASTE OIL WEIGHT SCALE"
5. Press **ENTER** to confirm.

```
Select:
Refrig. Weight scale
```

6.7.1 Refrigerant weight scale

1. Lift the knob on the back side of the machine, move it to the left and turn it in clockwise direction in order to lock it into "safety position".
2. Press **START** key to confirm scale unloaded.

```
Unload weight scale
(safety position)
```



WARNING! Confirm by **START** only if the scale is unloaded!

- At the end, bring back the knob to the “working position” (turn it counter-clockwise, move it slightly up and to the right, then fully down).

In case of mistake:
Perform again the procedure and be sure to follow correctly the instructions!

Reset not possible!
Scale not unloaded
PLS unload the scale
before reset.

6.7.2 Waste oil weight scale

- Disconnect the waste oil bottle from its coupler.
- Press **START** key to confirm bottle disconnected.



WARNING! Confirm by **START** only if the waste oil bottle is disconnected!

Unload used oil
scale!

- Wait the end, then reconnect the waste oil bottle.

7 Technical features

Technical features	COOLIUS Y50
Power	230V+/-10% 50Hz
Operating temperature range	10/49 °C
Refrigerant	R1234yf
Internal vessel capacity (Kg)	20 kg
Maximum pressure (PS)	20 bars
Compressor	3/8 HP
Recovery rate (liquid)	500 g/min'
Not condensable gas discharge	Automatic
Main drier filter	Type 660 Coaxial
Ventilation Security System	172 mm
Recovery high speed fan	172 mm
Internal vessel pressure gauge	D40 mm
Oil discharge – Environment friendly	Automatic
Bottle capacity (sealed)	250 ml
Refrigerant Weight scale	60 kg
Scale accuracy (+/-)	2 g
Nitrogen pressure test	Automatic
Vacuum pump	128 lt/min
Final pressure (McLeod abs)	0,05 mb
Electronic vacuum meter	YES

PAG oil charge	Automatic
Bottle capacity	250 ml
POE oil charge	Automatic
Bottle capacity	250 ml
UV Dye charge	Automatic
Bottle capacity	100 ml
Refrigerant charge	Automatic
Service hoses compensation	Automatic
Flushing program	On demand
Workshop program	YES
Configuration	
Display	4 x 20 characters
Keyboard with COOLIUS SELECT	YES
Car Database	YES
Printer	YES
Pressure gauges (pulse free) CL 1.0	D 80 mm
Service couplings	Parker SAE J639
Service hoses 3.0 m	SAE J2888
Service hoses extension kit to 6.0 m (additional 3.0 m)	On demand
Pocket document	YES

8 Disposal

8.1 Storage for long periods

The machine should be positioned in a safe area, disconnected from the supply and protected from excessive temperatures and humidity.

8.2 Disposal of used fluids



NOTE! *Used oil is hazardous waste. Do not mix used oil with other fluids.
Keep used oil in suitable containers prior to disposal.*

The lubricants extracted from A/C system must be delivered to used oil collection centre!

8.3 Disposal of packaging material

- The cardboard packaging material should be disposed of with other waste paper.
- Plastic packaging material should be added to other recyclable waste.

8.4 Scrapping the old unit

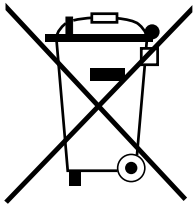

If you wish to scrap the Machine, first completely drain it of all liquids and dispose of them in an environmentally responsible manner.

Take the old unit to your nearest recycling centre or contact the customer service.



9 Contact and support



If you have further questions about the product or need help with the installation, our technical hotline staff will be happy to help you.

Contact information for your country's service partner can be found on our website  www.coolius-ac.com

Manufactured by:

WOW ! ITALY

Viale della Stazione 7
39100 Bolzano, Italy
Tel: +39 0546 - 060461

Distributed by:

WOW! Würth Online World GmbH

Schliffenstraße Falkhof
74653 Künzelsau

Phone: +49 7940 981 88 - 0
Fax: +49 7940 981 88 - 10 99
info@wow-portal.com
www.wow-portal.com

WABCOWÜRTH Workshop Services GmbH

Benzstr. 7
74653 Künzelsau

Phone: +49 7940 981863-0
Fax: +49 7940 981863-5555
info@wabcowuerth.com
www.wabcowuerth.com

AUTOCOM Diagnostic Partner AB

Grafitvägen 23 B
461 38 Trollhättan, Schweden

Phone: +46 520 470 701
Fax: +46 520 470 727
info@autocom.se
www.autocom.se

9.1 Service Portal COOLIUS-AC.COM

On the website  www.coolius-ac.com the activation of the machine can be carried out independently. In addition, you will find further help and instructions for your COOLIUS device on this website.

COOLIUS

WOW! ITALY
Viale della Stazione 7
39100 Bolzano
www.coolius-ac.com

Doc.No.: 22272_Rev.02.03
© by WOW! ITALY
All rights reserved.
Responsible for content: Product dept.

Reprinting, even in extract, is allowed only after obtaining approval.

We reserve the right to make changes to the product at any time, if we consider them to be in the interest of quality improvement, without prior notice or notification. Figures may be examples, which may differ in appearance from the goods delivered. We also reserve the right to errors, and cannot be held responsible for typographical mistakes. Our general terms and conditions apply.